

EQJW146F001

P100019097



Heating and District Heating Controller

Old > New	Firmware revisions
2.3x -> 2.4x	<p>New functions and parameters for buffer tank systems</p> <ul style="list-style-type: none"> - CO1 > F22: SLP depending on return flow temperature - CO5' > F01: AA1 reverse - CO5' > F07: Zero shift <p>New parameters in PA1 parameter level:</p> <ul style="list-style-type: none"> - Minimum set point to charge buffer tank - Stop charging of the buffer tank - Charging temperature boost - Lag time for storage tank charging pump <p>New parameters in PA4 parameter level:</p> <ul style="list-style-type: none"> - Maximum buffer tank temperature <p>New differential temperature control function (CO1 > F23) in systems Anl 1.0 and 16.0</p>
From 2.49	Valve transit time TY 120 s for Rk1, Rk2 and TW

Note on these mounting and operating instructions

These mounting and operating instructions assist you in mounting and operating the device safely. The instructions are binding for handling SAUTER devices.

➔ For the safe and proper use of these instructions, read them carefully and keep them for later reference.

Definition of signal words

DANGER

Hazardous situations which, if not avoided, will result in death or serious injury

NOTICE

Property damage message or malfunction

WARNING

Hazardous situations which, if not avoided, could result in death or serious injury

Note

Additional information

Tip

Recommended action

1	Safety instructions	4
1.1	Disposal	4
2	Operation	5
2.1	Operating controls	5
2.1.1	Rotary pushbutton	5
2.1.2	Rotary switch	5
2.2	Operating modes	6
2.3	Display	7
2.4	Activate the information level	8
2.5	Setting the time and date	9
2.6	Setting the times-of-use	10
2.7	Set day/night setpoints	12
3	Start up	13
3.1	Setting the system code number	13
3.2	Activating and deactivating functions	14
3.3	Changing parameters	15
3.4	Resetting to default settings	16
3.5	Keynumbers	16
4	Manual mode	18
5	Systems	19
6	Error during operation	25
6.1	Error list	25
6.2	Sensor failure	26
7	Communication	27
7.1	Memory module	29
8	Installation	30
9	Electrical connection	32
10	Appendix	34
10.1	Function block lists	34
10.2	Parameter lists	45
10.3	Resistance values	51
10.4	Technical data	52

1 Safety instructions

For your own safety, follow these instructions concerning the mounting, start up and operation of the controller:

- The device is to be mounted, started up or operated only by trained and experienced personnel familiar with the product.
- For electrical installation, you are required to observe the relevant electrotechnical regulations of the country of use as well as the regulations of the local power suppliers. Make sure all electrical connections are installed by trained and experienced personnel! Before performing any such work on the controller, disconnect it from the power supply.
- The device is designed for use in low voltage installations. For wiring and maintenance, you are required to observe the relevant regulations concerning device safety and electromagnetic compatibility.

To avoid damage to any equipment, the following also applies:

- Proper shipping and storage are assumed.
- Before start-up, wait until the controller has reached the ambient temperature.

1.1 Disposal

Waste electrical and electronic equipment may still contain valuable substances. They may also, however, contain harmful substances which were necessary for them to function. For this reason, do not dispose of this kind of equipment together with your household waste. Select a suitable disposal method. Instead, dispose of your waste equipment by handing it over to a designated collection point for the recycling of waste electrical and electronic equipment.

2 Operation

The controller is ready for use with the default temperatures and operating schedules. On start-up, the current time and date need to be set at the controller.

2.1 Operating controls

The operating controls are located in the front panel of the controller.

2.1.1 Rotary pushbutton

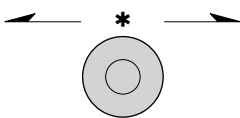

Rotary pushbutton

- Turn []:
Select readings, parameters and function blocks.
- Press []:
Confirm adjusted selection or settings.

2.1.2 Rotary switch

The rotary switch is used to set the operating mode and the relevant parameters for each control circuit.

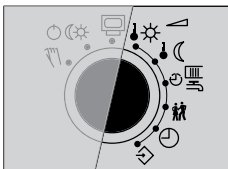
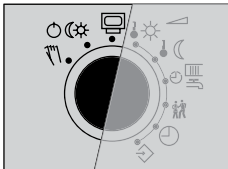

- Information level, normal switch position
- Operating modes
- Manual level
- Day set point (rated room temperature, DHW temperature)
- Night set point (reduced room temperature, DHW temperature sustaining value)
- Times-of-use for heating/DHW
- Party mode
- Controller time
- Parameter and configuration level

2.2 Operating modes

Day mode (rated operation): regardless of the programmed times-of-use and summer mode, the set points relevant for rated operation are used by the controller. Icon: ☀

Night mode (reduced operation): Regardless of the programmed times-of-use, the set points relevant for reduced operation are used by the controller. Icon: ☾

Control operation deactivated: regardless of the programmed times-of-use, control operation remains deactivated. The frost protection is activated, if need be. Icon: ⏸

Automatic mode: during the programmed times-of-use, the controller works in day mode (rated operation). Outside these times-of-use, the controller is in night mode (reduced operation), provided control operation has not been deactivated due to the outdoor temperature. The controller switches automatically between both operating modes. Icon: ⌚

Manual mode: valves and pumps can be controlled manually (see section 4). Icon: 🖱

Select the operating mode





1. Turn the rotary switch to ☀☀ (operating modes).
 - ▶ blinks.
 - In systems with only one control circuit (e.g. system An1 1.0), steps 2 and 3 (to select the control circuit) are not required.
2. Select the control circuit for which the operating mode is to be set [0]:
 - 1:** Heating circuit 1
 - 2:** Heating circuit 2
 - 3:** DHW heating/circulation pumpOnly those control circuits are available for selection which can be controlled by the selected system.
3. Confirm the selected control circuit [*].
4. Select operating mode [0]: ☀, ☾, ⏸ or ⌚.
5. Confirm the selected operating mode [*].
6. Turn the rotary switch back to normal switch position 🖱 (information level).

i Note

In automatic operation, the current phase of the time program (⌚ for day mode or ☀ for night mode) is displayed in the information level together with the ☾ icon.







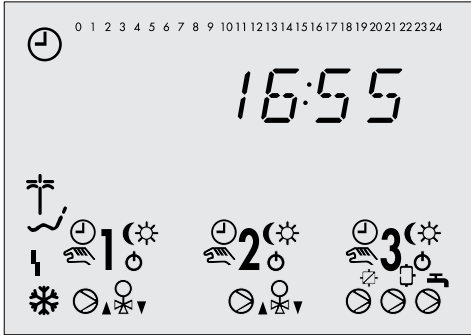

2.3 Display

In the normal switch position  (information level), the time as well as information on the controller are indicated on the display. Turn the rotary knob to read the times-of-use together with the temperature values of the various control circuits. The times-of-use and temperature values are represented by black squares below the row of numbers. Icons indicate the operating status of the controller.









-  Public holiday mode
-  Vacation mode
-  Error during operation
-  Frost protection











Heating circuit 1

-  Automatic mode
-  Night mode
-  Day mode
-  Manual mode
-  Control operation deactivated
-  Circulation pump (heating) UP1 ¹⁾
-  Valve HC1 OPEN
-  Valve HC1 CLOSED

Heating circuit 2

-  Automatic mode
-  Night mode
-  Day mode
-  Manual mode
-  Control operation deactivated
-  Circulation pump (heating) UP2 ¹⁾
-  Valve HC2 OPEN
-  Valve HC2 CLOSED

DHW circuit

-  Automatic mode
-  Night mode
-  Day mode
-  Manual mode
-  Control operation deactivated
-  Pump output TLP/CP ¹⁾
-  Storage tank charging pump SLP ¹⁾
-  Circulation pump (DHW) ZP ¹⁾

¹⁾ UP1, UP2, TLP, CP, SLP and ZP indicate possible choices for pump selection in manual mode.

Fig. 1: Icons

The controller status can be displayed in the information level (see section 2.4).

2.4 Activate the information level

In the normal switch position  (information level), the time, date, public holidays and vacation periods as well as the temperatures of connected sensors and their set points can be displayed.











i Note

The data can also be read in the operating level  (manual mode). In this case, select and confirm **Info** on the display and proceed as described below.

Proceed as follows:

1. Select value [].

Depending on how the controller is configured, the current values of the following data points appear one after the other on the display:

-  Time
-  Room temperature of heating circuit 1, 2
-  Outdoor temperature
-  Temperature at flow sensor VF, heating circuit 1, 2
-  Temperature at flow sensor VF1, primary heat exchanger circuit
-  Temperature at flow sensor VF2, VF4, DHW circuit
-  Temperature at solar collector sensor VF3
-  Temperature at return flow sensor RüF
-  Temperature at storage tank sensor SF1
-  Temperature at storage tank sensor SF2
-  Temperature at storage tank sensor of solar circuit

2. Confirm a data point [] to read the associated set point/limit. The date is displayed when the time reading appears.

2.5 Setting the time and date

The current time and date need to be set immediately after start-up and after a power failure lasting more than 24 hours. This is the case when the time blinks on the display.

Proceed as follows:

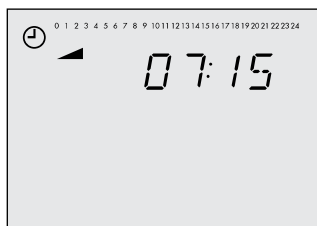

1. Turn the rotary switch to ☹ (controller time).
Reading: Time, ☹ and ◀ blink.
2. Change the time [↻].

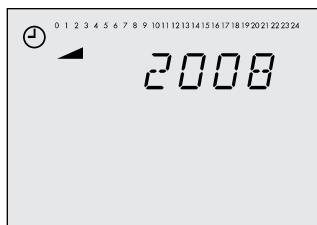

3. Confirm the time setting [*].
Reading: Year
4. Change year [↻].

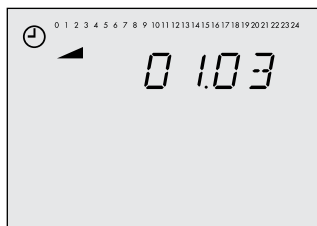

5. Confirm year [*].
Reading: Date (day.month)
6. Change date [↻].
7. Confirm the date setting [*].
Reading: Time
8. Turn the rotary switch back to normal switch position ☺ (information level).

i Note

The correct time is guaranteed after a power failure of 24 hours. Normally, the correct time is still retained at least 48 hours after a power failure.

2.6 Setting the times-of-use

Three times-of-use can be set for each day of the week.

Parameters	Default ¹⁾	Value range
Period/day	1-7	1-7, 1, 2, 3, 4, 5, 6, 7 with 1-7 daily, 1 = Monday, 2 = Tuesday, ..., 7 = Sunday
Start first time-of-use	06:00	00:00 to 24:00 h; in steps of 15 minutes
Stop first time-of-use	22:00	00:00 to 24:00 h; in steps of 15 minutes
Start second time-of-use	22:15	00:00 to 24:00 h; in steps of 15 minutes
Stop second time-of-use	22:15	00:00 to 24:00 h; in steps of 15 minutes
Start third time-of-use	--	00:00 to 24:00 h; in steps of 15 minutes
Stop third time-of-use	--	00:00 to 24:00 h; in steps of 15 minutes

¹⁾ Default settings applicable to the heating circuits

Proceed as follows:

1. Turn the rotary switch to  (times-of-use).

▲ blinks.

In systems with only one control circuit (e.g. system An1 1.0), steps 2 to 5 (to select the control circuit and configure the DHW circuit) are not required.

In systems An1 1.5 and 1.9, only the DHW circuit is controlled. As a result, steps 2 and 3 (to select the control circuit) are not required.

2. Select the control circuit for which the time-of-use is to be programmed.

1: Heating circuit 1

2: Heating circuit 2

3: DHW heating/circulation pump

Only those control circuits are available for selection which can be controlled by the selected system.

3. Confirm the selected control circuit [*****].

If control circuit 1 or 2 has been selected, steps 4 and 5 are not required.

4. Configure DHW circuit []:



DHW heating



Circulation pump (DHW)

5. Confirm setting [*****].

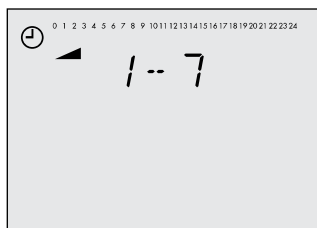

6. Select period/day for which the times-of-use are to be valid [⌚].

1-7 = daily

1 = Monday, 2 = Tuesday, ..., 7 = Sunday

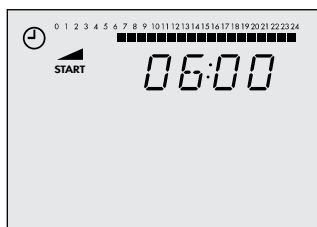

7. Activate editing mode for the period/day [*].

Reading: **START**, ⌚ and ◀ blink.

8. Change start time [⌚].

The time is set in steps of 15 minutes.

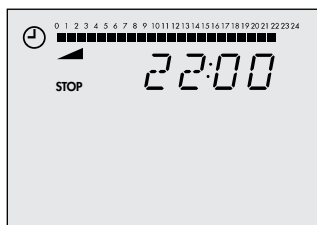

9. Confirm the start time setting [*].

Reading: **STOP**

10. Change stop time [⌚].

The time is set in steps of 15 minutes.

11. Confirm the stop time setting [*].

Reading: **START**

The displayed time is the stop time of the first time-of-use period plus 15 minutes.

➔ To set the second and third times-of-use periods, repeat steps 8 to 11.

➔ If no further times-of-use are to be programmed for the selected time period/day, exit the menu by confirming the indicated start time twice (2x [*]).

➔ For programming every day separately, repeat steps 6 to 11.

12. Once you have programmed all times-of-use: Turn the rotary switch back to normal switch position  (information level).

i Note

Do not use the 1-7 menu to check the programmed times-of-use. If this menu is opened after the times-of-use have been programmed, the schedule programmed for Monday is also adopted for all other days of the week.

Operation

2.7 Set day/night setpoints

For the heating circuits, the desired room temperature for the day ('Day setpoint') and a reduced room temperature for the night ('Night setpoint') can be specified to the controller and a reduced room temperature for the night ('Night setpoint') can be set. In the DHW circuit, the temperature to which the DHW is to be heated can be set to be heated.

Switch position

Parameter	WE	Value range
Day setpoint Rk1, Rk2	20 °C	-5,0 bis +150,0 °C
Setpoint drinking water temperature	60 °C	min. to max. drinking water temperature

Switch position

Parameter	WE	Value range
Night setpoint Rk1, Rk2	15 °C	-5,0 bis +150,0 °C
Setpoint drinking water temperature	40 °C	min. to max. drinking water temperature

Procedure

1. Turn the rotary switch to the desired data point:



for day setpoint or DHW temperature setpoint



for night setpoint or domestic hot water temperature hold value



flashes.

3 Start-up

The modifications of the controller configuration and parameter settings described in this section can only be performed after the valid key number has been entered.

The key number that is valid on the first start-up can be found in chapter 3.5.









3.1 Setting the system code number

Different hydraulic schematics are available. Each system configuration is represented by a system code number. The different schematics are dealt with in section 5. Available controller functions are described in sections 6, 7 and 8.

Changing the system code number resets previously adjusted function blocks to their default settings (WE). Function block parameters and parameter level settings remain unchanged.

The system code number is set in the configuration and parameter level.

Proceed as follows:

1. Turn the rotary switch to  (parameter and configuration level).
Reading: **0 0 0 0**
2. Enter valid key number []
3. Confirm key number []
Reading: **PA_**
4. Select **Anl** on the display.
5. Activate editing mode for the system code number []
  blinks.
6. Select system code number []
7. Confirm system code number []
Reading: **End**
8. Turn the rotary switch back to normal switch setting  (information level).

3.2 Activating and deactivating functions

A function is activated or deactivated in the associated function block. 0 to 24 at the top of the display represent the function block numbers. When a configuration level is opened, the activated function blocks are indicated by a black square on the right-hand side below the function block number.

The functions are grouped by topics:

- CO1: HC1 (heating circuit 1)
- CO2: HC2 (heating circuit 2)
- CO4: DHW circuit
- CO5: System-wide
- CO6: Modbus communication

1. Turn the rotary switch to \diamond (parameter and configuration level).

Reading: **0 0 0 0**

2. Enter valid key number [\diamond].

3. Confirm key number [\ast].

Reading: **PA_**

4. Select configuration level [\diamond].

5. Open configuration level [\ast].

6. Select function block [\diamond].

Activated function blocks are marked '1'.

Deactivated function blocks are marked '0'.

7. Activate editing mode for the function block [\ast].

◀ blinks.

8. Activate function block [\diamond].

Reading: **F__ - 1**

An activated function block is indicated by a black square below (right) the function block number at the top of the controller display.

or:

Deactivate function block [\diamond].

Reading: **F__ - 0**

9. Confirm setting [*].

If the function block is not closed, further function block parameters can be adjusted.

10. Select **End** [↵].

11. Exit configuration level [*].

➔ To set further function blocks in other configuration levels, repeat steps 4 to 9.

12. Turn the rotary switch back to normal switch setting  (information level).

i Note

All function block settings are saved in a non-volatile memory in the controller.

3.3 Changing parameters

Depending on the system code number selected and the activated functions, not all parameters listed in the parameter list in the appendix might be accessible.

The parameters are grouped by topics:

- PA1: HC1 (heating circuit 1)
- PA2: HC2 (heating circuit 2)
- PA4: DHW circuit
- PA5: System-wide
- PA6: Communication parameters

1. Turn the rotary switch to  (parameter and configuration level).

Reading: **0 0 0 0**

2. Enter valid key number [↵].

3. Confirm key number [*].

Reading: **PA_**

Start-up

4. Select parameter level [↻].
 5. Open parameter level [*].
 6. Select parameter [↻].
 7. Activate editing mode for the parameter [*].
 - ▶ blinks.
 8. Change parameter [↻].
 9. Confirm parameter [*].
- ➔ To set further parameters in the opened parameter level, repeat the steps 6 to 9.
10. Select **End** [↻].
 11. Exit parameter level [*].
- ➔ To set further parameters in another parameter level, repeat the steps 4 to 9.
12. Turn the rotary switch back to normal switch setting  (information level).

i Note

All parameter settings are saved in a non-volatile memory in the controller.

3.4 Resetting to default settings

All parameters set over the rotary switch as well as parameters in the PA1, PA2 and PA5 parameter levels can be reset to their default settings (WE) except for the maximum flow temperature and the return flow temperature limits in PA1 and PA2.

1. Turn the rotary switch to  (parameter and configuration level).

Reading: **0 0 0 0**

2. Enter key number 1991 [↻].
3. Confirm key number [*].

The controller loads the default settings.

Reading: **0 0 0 0**

3.5 Keynumbers

- 1732** General parameter setting and configuration
- 1999** Enable/disable extended information level
- 1995** Change code number for parameterization and configuration
- 1991** Load factory setting
- 0002** Restart







4 Manual mode

Switch to manual mode to configure all outputs.

NOTICE

*Risk of damage of the heating circuit through low temperatures.
The frost protection does not function when the controller is in manual mode.*

Proceed as follows:

1. Turn the rotary switch to  (manual level).
2. Select output depending on the control circuit []:
 - POS_ Correction value adjusted in percent
 - UP_ Switching of the circulation pump (heating)
 - SLP Switching of the storage tank charging pump
 - TLP Switching of the heat exchanger charging pump
 - CP Switching of the solar circuit pump
 - ZP Switching of the circulation pump (DHW)
3. Confirm output [].
The reading blinks.
4. Change the positioning value/switching state [].
5. Confirm change [].
The modified values remain active as long as the controller is in manual mode.
6. Turn the rotary switch back to normal switch setting  (information level).
The manual mode is deactivated.

i Note

The outputs of the controller are not affected by merely turning the rotary switch to  (manual level). The outputs are only changed by entering or changing the positioning values or switching states.

5 Systems

Different hydraulic schematics are available.

The plants can be designed as primary or secondary systems. The main hydraulic differences between the primary and second systems are shown in Fig. 3.

1. A mixing valve replaces the heat exchanger in the heating circuit/DHW circuit.
2. A storage tank charging pump replaces the solenoid valve/thermoelectric valve in the primary system.

Do not change the controller settings.

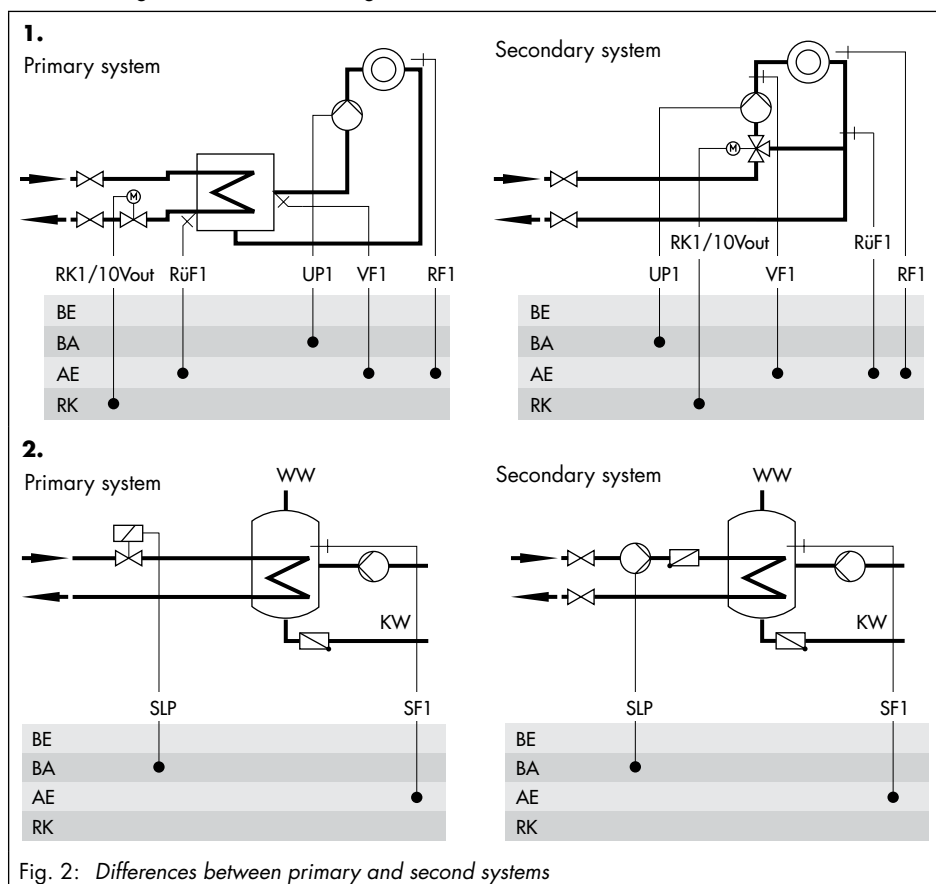

Systems

Boiler plants

Single-stage boiler systems can be configured to include any system whose heating circuits and DHW circuit include just one heat exchanger. These systems are Anl 1.0, 1.5, 1.6, 2.x, 3.0, 3.5, 4.0, 4.1 and 16.x.

The boiler can be controlled by an on/off output (CO1 > F12 - 0).

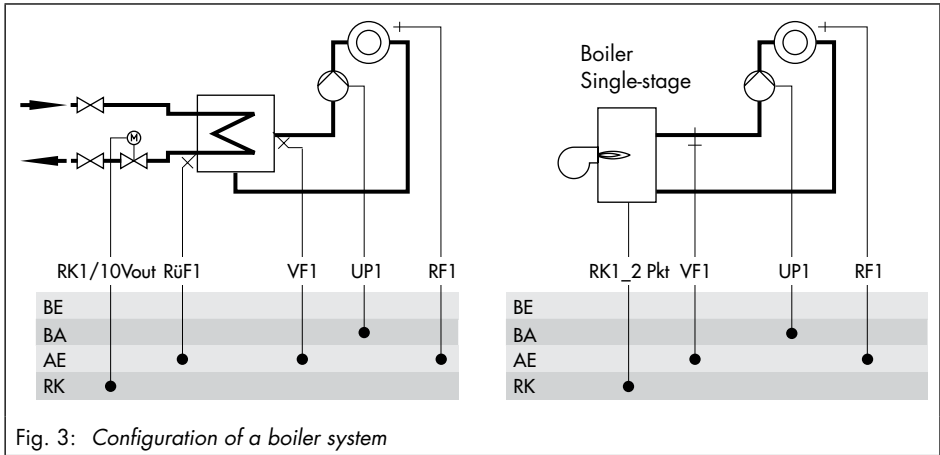

System Anl 1.0

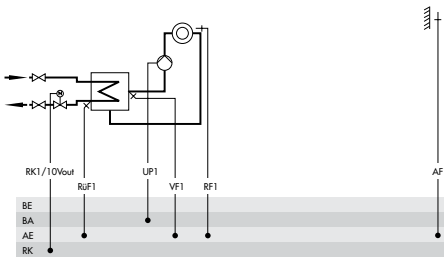

Systems Anl 1.1 to 1.3

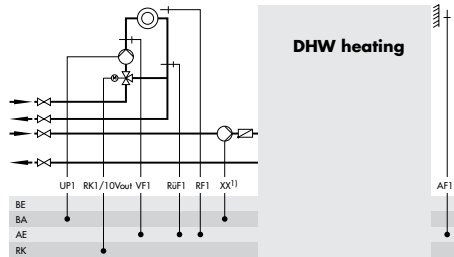

System Anl 1.5

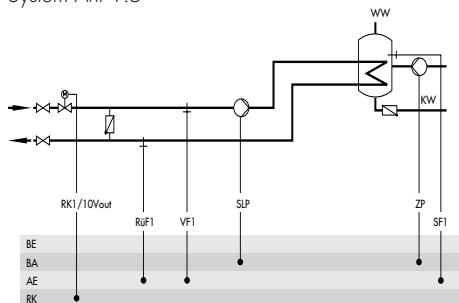

System Anl 1.6

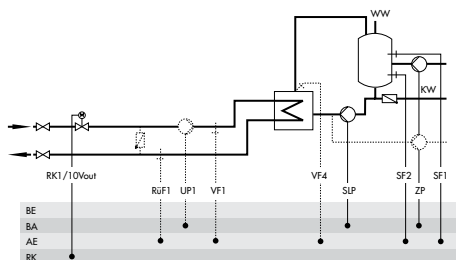

System Anl 1.9

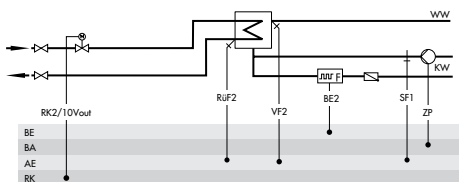

System Anl 2.0

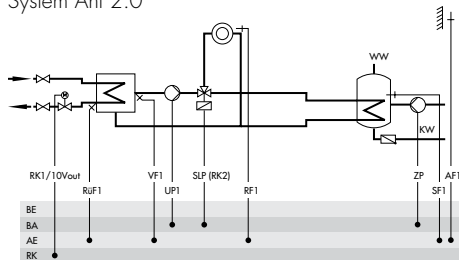

Systems Anl 2.1 to 2.3

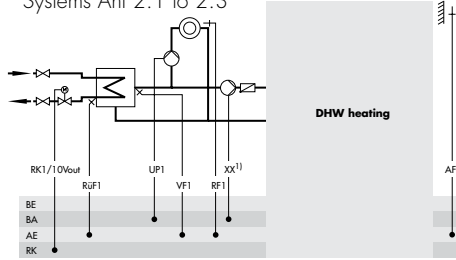

System Anl 3.0

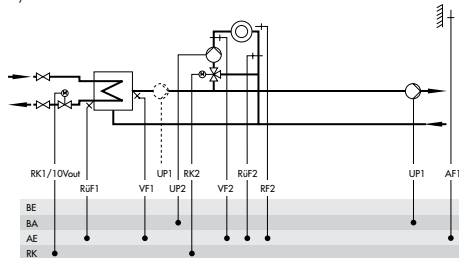

System Anl 3.5

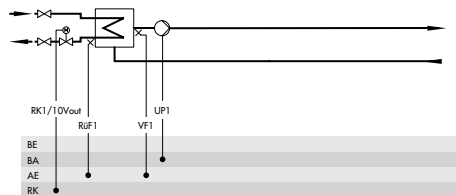

Systems

System Anl 4.0

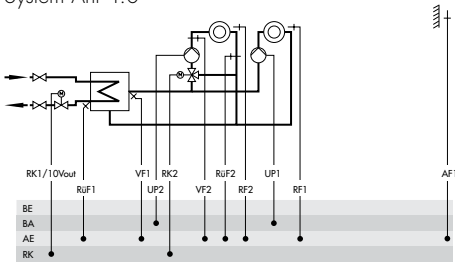

System Anl 4.1

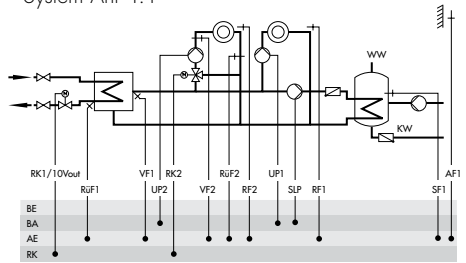

System Anl 4.5

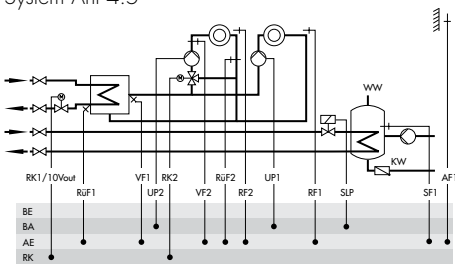

System Anl 10.0

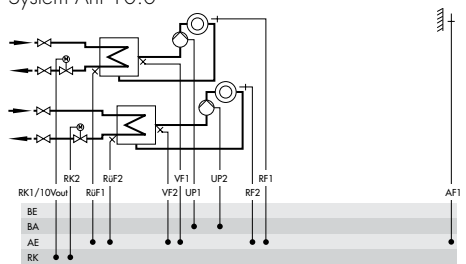

System Anl 11.0

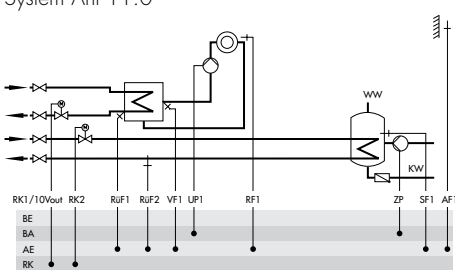

System Anl 11.1

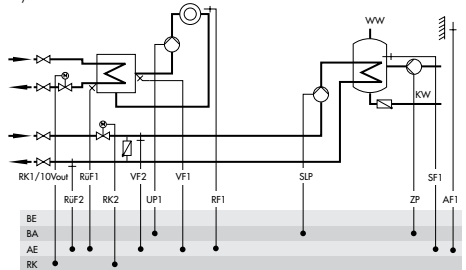

System Anl 11.2

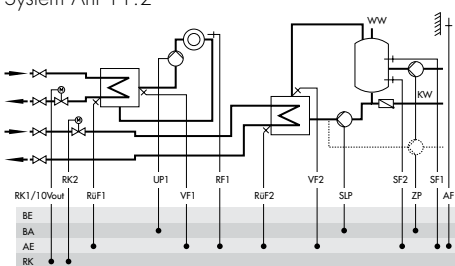

System Anl 11.1/11.2 with buffer storage tank

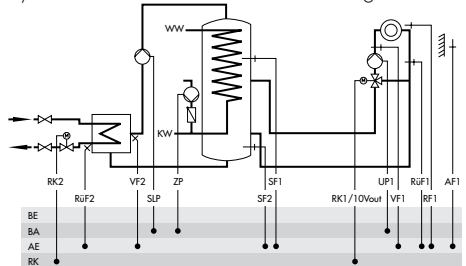

System Anl 11.5

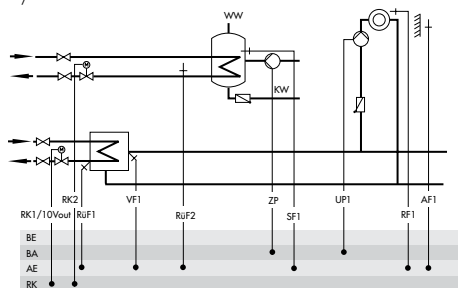

System Anl 11.6

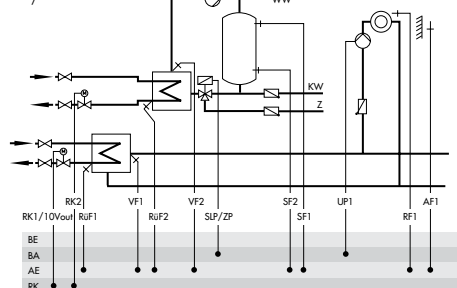

System Anl 11.9

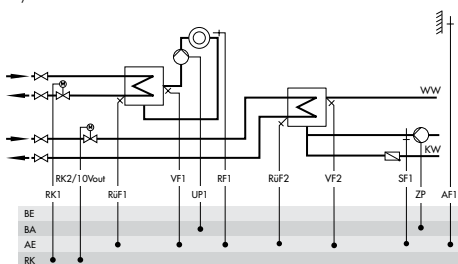

System Anl 16.0

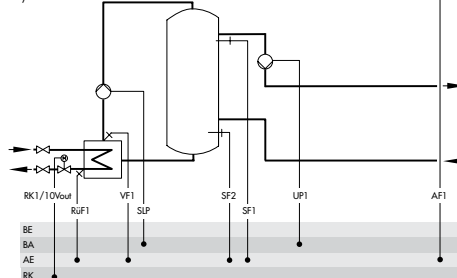

System Anl 16.1

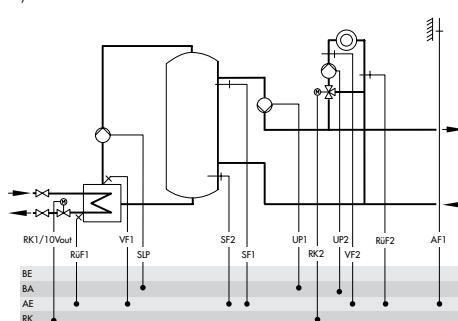

System Anl 16.2

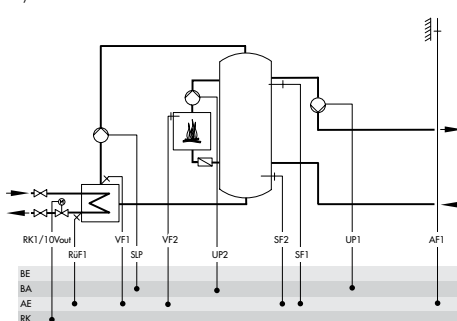

Systems

System Anl 16.3

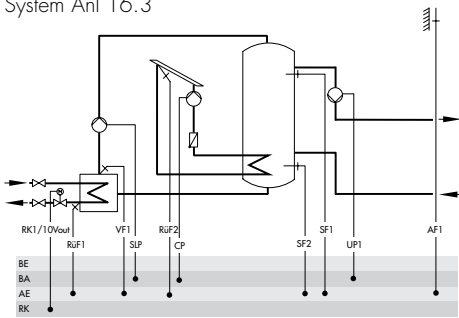

System Anl 16.4

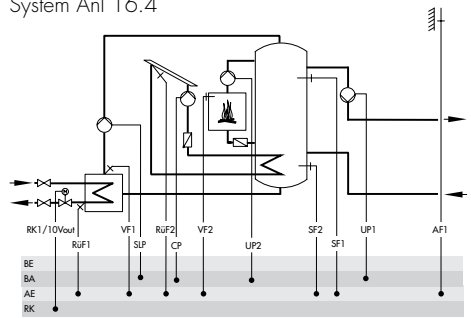

System Anl 16.6

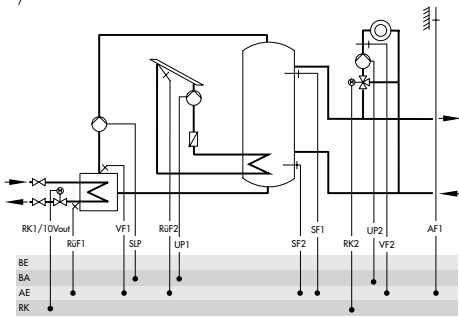

DHW heating

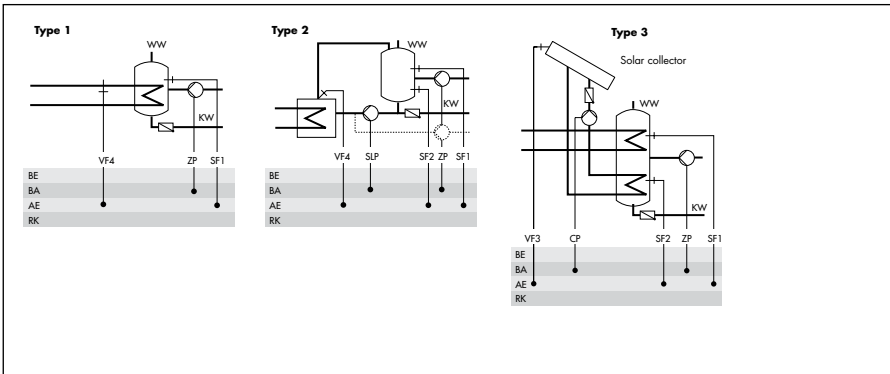

6 Error during operation

The **i** icon blinks on the display when a sensor fails. Additionally, the display is illuminated for one second every 10 seconds upon sensor failure. 'Error' is immediately indicated. Press the rotary pushbutton to open the error level. Turn the rotary knob to read the error or possibly more. As long as an malfunction exists, the error message is included in the reading loop, even when it has not been opened by pressing the rotary pushbutton.

i Note

After the system code number has been changed or after restarting the controller, any error messages are suppressed for approx. three minutes.

6.1 Error list

Err 1 = Sensor failure

Err 2 = Reserved

Err 3 = Disinfection temperature not reached (see manual)

Err 4 = Max. charging temperature reached (see manual)

Err 5 = Reserved

Err 6 = Temperature monitor alarm (see manual)

Err 7 = Unauthorized access occurred

Err 8 = Error message of a binary input

All error messages, except for Err 1 can be confirmed in the error level.

Confirming error messages

1. Select **Clr** [**↶**].
2. Confirm error message [*****].

6.2 Sensor failure

As described in the error list, sensor failures are indicated by displaying Err 1 error message in the error level. For detailed information, exit the error level and view the different temperature values in the information level: each sensor icon displayed together with three dashes instead of the measured value indicates a defective sensor. The following list explains how the controller responds to the failure of the different sensors.

- **Outdoor sensor AF1:** when the outdoor sensor fails, the controller uses a flow temperature set point of 50 °C or the 'Max. flow temperature' when the max. flow temperature (set in PA1, 2) is lower than 50 °C. With the setting CO1, 2 > F05 - 1 (underfloor heating), the flow temperature set point is 30 °C in the event of a malfunction.
- **Flow sensor(s) in heating circuit(s):** when the flow sensors in the heating circuits are defective, the associated valve moves to 30 % travel. DHW heating using such a sensor to measure the charging temperature is suspended.
- **Flow sensors in the DHW circuit with control valve:** when the flow sensor VF4 fails, the controller behaves as if VF4 has not been configured. As soon as the control of the charging temperature/DHW temperature becomes impossible (VF2 defective), the associated valve is closed.
- **Return flow sensors RÜF1/2:** when the return flow sensor fails, the controller continues operation without return flow temperature limitation.
- **Room sensors RF1/RF2:** when the room sensor fails, the controller uses the settings for operation without room sensor. The controller, for example switches from optimizing mode to reduced operation. The adaptation mode is canceled. The last determined heating characteristic remains unchanged.
- **Storage tank sensors SF1/SF2:** when one of the two sensors fails, the storage tank is no longer charged (exception: solar system).
- **Solar circuit sensors SF3, VF3:** When one of the two sensors fails, the storage tank in the solar circuit is no longer charged.

6.3 Temperature monitoring

If a control deviation greater than 10 °C occurs in a control circuit for a period of 30 minutes, an error message "Err 6" (temperature monitoring alarm) is generated.

Function	WE	Configuration
Temperature monitoring	0	CO5 > F19 -1

6.4 Error status register

The error status register is used to report controller or system malfunctions.

Error message	Meaning	Decimal valency	
Err 1	Sensor failure	1	1
Err 2	—	2	
Err 3	Disinfection temperature not reached	4	
Err 4	Maximum charging temperature reached	8	
Err 5	—	16	
Err 6	Temperature monitoring alarm	32	32
Err 7	Unauthorised access has taken place	64	
Err 8	Error message of a binary input	128	
Err 9	—	256	
Example: Value of the error status register in case of sensor failure and alarm temperature monitoring =			33

7 Communication

Using the optional controller EQJW126/146 communication module, the SAUTER EQJW146F001 Heating Controller can communicate with a control system. In combination with a suitable software for process visualization and communication, a complete control system can be implemented.

The following communication variants are possible:

- Operation with RS232C connection on communication module 0440210001 (1)
- Operation via RS485 two-wire bus at the communication module 0440210003 or 0440210004 (2)
- Operation via RS485 two-wire bus with cable converter 0440210012 (2)
- Operation with dial-up modem on communication module 0440210002 (3)
- Operation with Modbus GPRS gateway 0440210011 (4)
- Operation on a RS485 two-wire bus at the Modbus-MBus-gateway 0440210006 (5)
- Operation with LAN connection at Modbus TCP gateway 0440210005 (6)

In principle, automatic communication via a dial-up modem is only established if faults occur in the system. The controller operates autonomously, but can be dialed up, read out and, if necessary, influenced at any time over the modem.

As an alternative to the control station connection, the device bus allows direct data exchange between the controllers.

- Operation with device bus and communication modules, 0440210001 and 0440210002, 0440210003 and 0440210004 or with cable converter 0440210012

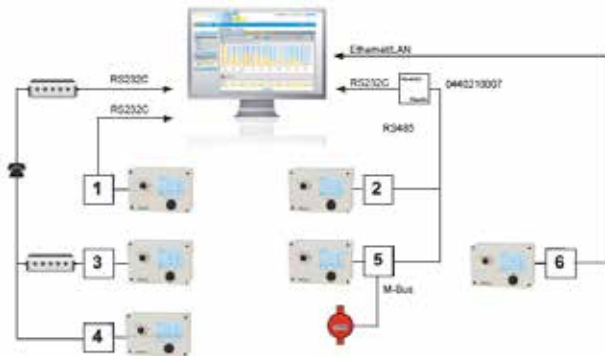

All communication modules are designed for operation at the communication interface coordinated. The interface properties cannot be parameterized.

Property	Setting
Baud rate	19200 Baud
Data bit, parity, stop bit	8 bits, none (no), 1 stop bit

For more details on the Communication accessory, refer to the Communication Connection Manual.

7.1 Memory module

The use of a memory module (0440210010) is particularly useful for transferring all set data from one EQJW146F001 controller to several other EQJW146F001 controllers memory module (0440210010).

The memory module is connected to the RJ-45 socket on the side. After connection, “73 SP” is shown in the controller display. If the memory module already contains data from another controller EQJW146F001, the display “SP 73” can be called up by turning the control knob.

- Confirming the display “73 SP” by pressing the control knob leads to the transfer of the controller setting into the memory module.
- Confirming the display “SP 73” by pressing the control knob leads to the transfer of data from the memory module to the controller.

During the data exchange, the bar graph in the display is used as a running light. After successful data transfer, “I.O.” is displayed. Afterwards, the connection between the controller and the memory module/minimodule can be disconnected.

8 Installation

The controller can be fitted with a standard base or with a high housing base.

Dimensions in mm (W x H x D)

- Controller with standard base: 144 x 98 x 54
- Controller with high base: 144 x 98 x 75

The controller consists of the housing with the electronics and the back panel with the terminals. The device is suitable for panel, wall and top hat rail mounting (see Fig. 12).

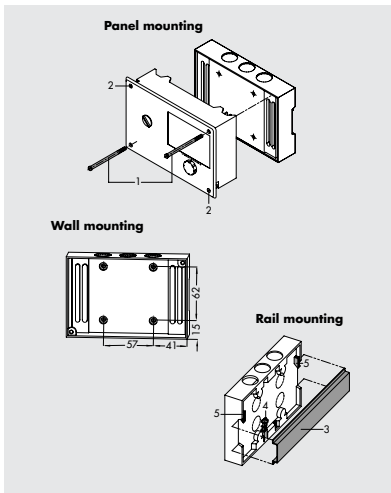

9 Electrical connection

⚠ DANGER

Risk of electric shock!

- For electrical installation, you are required to observe the relevant electrotechnical regulations of the country of use as well as the regulations of the local power suppliers. Make sure all electrical connections are installed by trained and experienced personnel.
- The terminals 25 and 28 allow safety equipment which have a direct influence on individual electric actuators to be integrated. If an internal power supply is to be used, connect a jumper from terminal 18 to terminals 25 and 28. Do not connect ELV wiring (according to VDE 0100) to these terminals.
- Before performing any work on the controller, disconnect it from the power supply.

Notes on electric wiring

- Install the 230 V power supply lines and the signal lines separately! To increase immunity, keep a minimum distance of 10 cm between the lines. Make sure the minimum distance is also kept when the lines are installed in a cabinet.
- The lines for digital signals (bus lines) and analog signals (sensor lines, analog outputs) must also be installed separately!
- In plants with a high electromagnetic noise level, we recommend using shielded cables for the analog signal lines. Ground the shield at one side, either at the control cabinet inlet or outlet, using the largest possible cross-section. Connect the central grounding point and the PE grounding conductor with a 10 mm² cable using the shortest route.
- Inductances in the control cabinet, e.g. contactor coils, are to be equipped with suitable interference suppressors (RC elements).
- Control cabinet elements with high field strength, e.g. transformers or frequency converters, must be shielded with separators providing a good ground connection.

Overvoltage protection

- If signal lines are installed outside buildings or over large distances, make sure appropriate surge or overvoltage protection measures are taken. Such measures are indispensable for bus lines.
- The shield of signal lines installed outside buildings must have current conducting capacity and must be grounded on both sides.
- Surge diverters must be installed at the control cabinet inlet.

Electrical connection

Connecting the controller

The controller is connected as illustrated in the following wiring diagrams.

- Open the housing to connect the cables.
- To connect the feeding cables, make holes in the marked locations at the top, bottom or back of the base of the housing and fit suitable grommets or cable glands.

Connecting sensors

Cables with a minimum conductor cross-section of 0.5 mm² can be connected to the terminals at the base of the housing.

Connecting actuators

- 0 to 10 V control output: use cables with a minimum conductor cross-section of 0.5 mm².
- Three-step or on/off outputs: connect cables with at least 1.5 mm² suitable for damp locations to the terminals of the controller output. We recommend checking the direction of travel at start-up.

Connecting pumps

- Connect all cables with at least 1.5 mm² to the terminals of the controller as illustrated in the wiring diagram.

i Note

The electric actuators and pumps are not automatically supplied with a voltage by the controller. They can be connected over terminals 20, 22, 25 and 28 to an external voltage source. If an internal power supply is to be used, connect a jumper from terminal 18 to terminals 20, 22, 25 and 28.

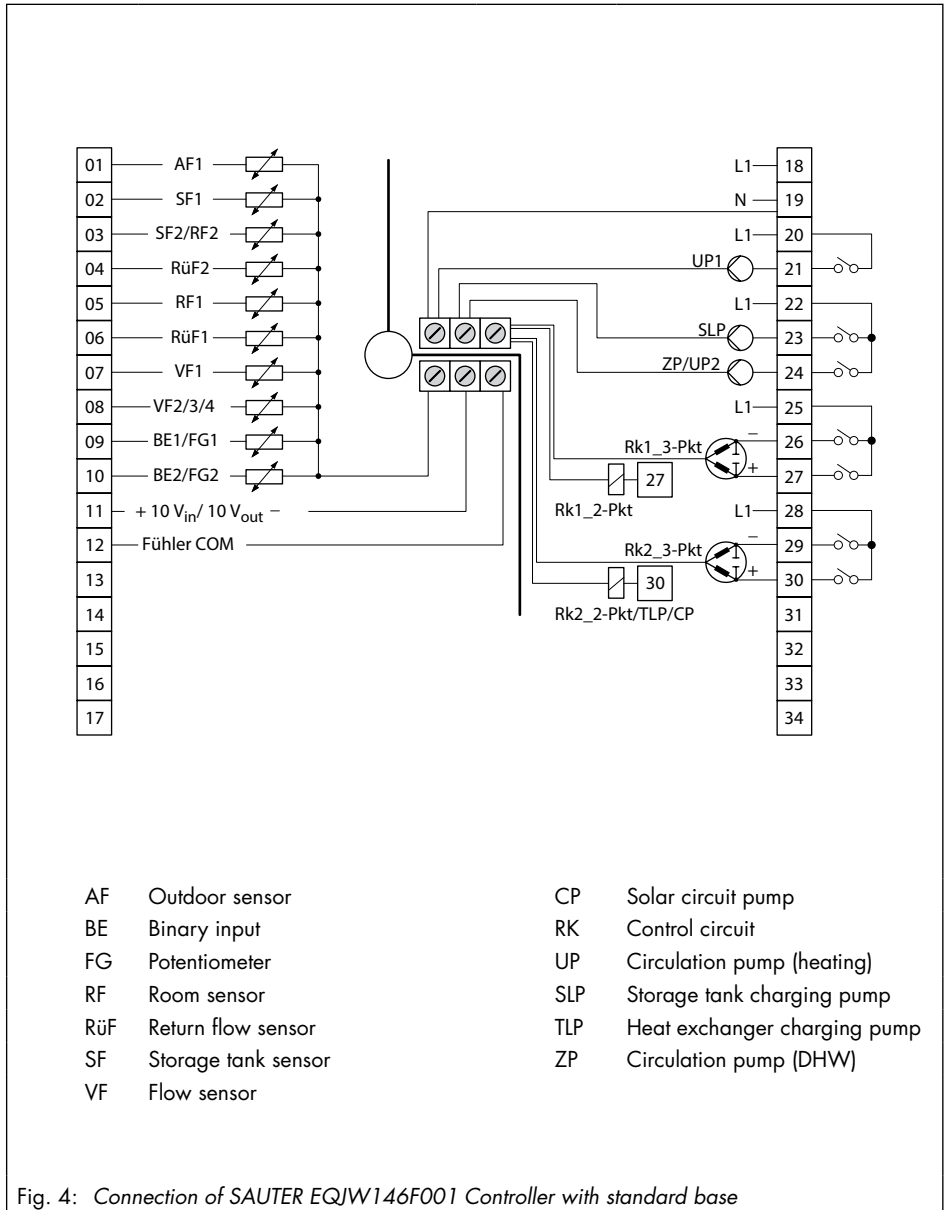

Fig. 4: Connection of SAUTER EQJW146F001 Controller with standard base

10 Appendix

10.1 Function block lists

CO1: HC1 - Heating circuit 1 (not system Anl 1.9)*

F	Function	WE	Anl	Comments Function block parameters: value range (default setting)
01	Room sensor RF1	0	Not systems Anl 1.5, 1.6, 3.x, 16.x	CO1 > F01 - 1: Room sensor RF1 active
02	Outdoor sensor AF1	0	1.5, 1.6	CO1 > F02 - 1: Outdoor-temperature-compensated control active
		1	Not Anl 1.5, 1.6	
03	Return flow sensor RfF1	0	1.2	CO1 > F03 - 1: Sensor and limitation function active Function block parameters: KP (limiting factor): 0.1 to 10.0 (1.0)
		1	Not Anl 1.2	
04	Cooling control	0	All*	CO1 > F04 - 1: Cooling control, only with CO1 > F11 - 1 The cooling control function causes a reversal of the operating direction and a minimum limitation of the return flow temperature in HC1.
05	Underfloor heating Drying of jointless floors	0	Not systems Anl 1.5, 1.6, 3.x, 16.x	CO1 > F05 - 1: Restriction of the adjustment ranges Function block parameters: Start temperature: 20.0 to 60.0 °C (25 °C) Hold (days): 0 to 10 days (0) Temp. rise/day: 0.0 to 10.0 °C (5.0 °C) Maximum temperature: 25.0 to 60.0 °C (45.0 °C) Hold (days): 0 to 10 days (4) Temp. reduction/day: 0.0 to 10.0 °C (0.0 °C) SToP, ■STArT, ■■STArT, ■■■STArT, ■■■■STArT
06	Storage tank sensor SF2	1	System Anl 16.x only	CO1 > F06: Activate SF2 to switch off charging of the buffer tank
07	Optimization of heating times	0	Not systems Anl 1.5, 1.6, 3.x, 16.x	CO1 > F07 - 1: only with CO1 > F01 - 1 and CO1 > F02 - 1
08	Adaptation of the heating characteristic curve	0	Not systems Anl 1.5, 1.6, 3.x, 16.x	CO1 > F08 - 1: only with CO1 > F01 - 1, CO1 > F02 - 1 and CO1 > F11 - 0
09	Flash adaptation of the flow temperature	0	Not systems Anl 1.5, 1.6, 3.x, 16.x	CO1 > F09 - 1: only with CO1 > F01 - 1 Function block parameters: Cycle time: 0 or 1 to 100 min (20 min) KP (gain): 0.0 to 25.0 (0.0)
10	Reserved			
11	Four-point characteristic	0	Not Anl 1.5, 1.6	CO1 > F11 - 1: Four-point characteristic, only with CO1 > F08 - 0 CO1 > F11 - 0: Gradient characteristic

F	Function	WE	Anl	Comments
12	Control mode	1	All*	<p>CO1 > F12 - 1: Three-step control</p> <p>Function block parameters: KP (gain): 0.1 to 50.0 (2.0) Tn (reset time): 1 to 999 s (120 s) TV (derivative-action time): 0 to 999 s (0 s) TY (valve transit time): 15, ..., 240 s (120 s)</p> <p>CO1 > F12 - 0: On/off control</p> <p>Function block parameters: Hysteresis: 1.0 to 30.0 °C (5.0 °C) Min. ON time: 0 to 10 min (2 min) Min. OFF time: 0 to 10 min (2 min)</p>
13	Limitation of set point deviation for OPEN signal	0	All*	<p>CO1 > F13 - 1: only with CO1 > F12 - 1</p> <p>Function block parameters: Max. system deviation: 3.0 to 10.0 °C (3.0 °C)</p>
14	Release HC1 at input BI1	0	All*	<p>CO1 > F14 - 1: FG1 has no function</p> <p>Select: BI = 1, BI = 0 (BI = 1)</p>
15	Demand processing in HC1	0	All*	How the demand is processed in HC1 depends on the configuration of CO1 > F16, CO1 > F17 and CO7 > F15.
16	Demand processing, 0 to 10 V Input terminals 11/12	0	All*	<p>CO1 > F16 - 1: only with CO1 > F15 - 1 and CO1 > F17 - 0</p> <p>Function block parameters: Lower transmission range: 0 to 150 °C (0 °C) Upper transmission range: 0 to 150 °C (120 °C) The standardized signal output (terminals 11/12) is not available anymore as a control output.</p>
17	Binary demand processing Input terminals 03/12	0	Not for systems with SF2/RF2	<p>CO1 > F17 - 1: only with CO1 > F15 - 1 and CO1 > F16 - 0</p> <p>Select: BI = 1, BI = 0 (BI = 1)</p>
18	Request max. flow set point using 0 to 10 V Output terminals 11/12	0	All*	<p>CO1 > F18 - 1: the standardized signal output (terminals 11/12) is not available anymore as a control output. The maximum flow set point (with boost, if applicable) is demanded as a 0 to 10 V signal at the standardized signal output.</p> <p>Function block parameters: Lower transmission range: 0.0 to 150.0 °C (0.0 °C) Upper transmission range: 0.0 to 150.0 °C (120.0 °C) Boost flow temperature demand: 0 to 30.0 °C (0 °C)</p>
20	External demand for heat due to insufficient heat supply	0	All	CO1 > F20 - 1: Demand of an external heat source

Appendix

F	Function	WE	Anl	Comments Function block parameters: value range (default setting)
21	Speed reduction of charging pump	0	16.x	CO1 > F21 - 1: Temperature-based adaptation of the delivery rate of the charging pump Function block parameters: Start speed reduction - SF2 limit: 5.0 to 90.0 °C (40.0 °C) Stop speed reduction - SF2 limit: 5.0 to 90.0 °C (50.0 °C) Minimum speed: 0 to 50 % (20 %)
22	SLP depending on return flow temperature	0	16.x	CO1 > F22 - 1: Storage tank charging pump not ON unless return flow hot
23	Differential temperature control	0	System Anl 1.0, 16.0 only	CO1 > F23 - 1: Activation of differential temperature control Function block parameters: Set point of differential temperature control: 0.0 to 50.0 °C (20.0 °C) KP (influence factor): 0.1 to 10.0 (1.0) Minimum speed: 0 to 100 % (20 %)

F Function block number, WE Default setting, Anl System code number

CO2: HC2 · Heating circuit 2 (systems Anl 3.x, 4.x, 10.0, 16.6)*

F	Function	WE	Anl	Comments Function block parameters: value range (default setting)
01	Room sensor RF2	0	All*	CO2 > F01 - 1: Room sensor RF2 active
03	Return flow sensor RfF2	1	10.x	CO2 > F03 - 1: Sensor and limitation function active Function block parameters: KP (limiting factor): 0.1 to 10.0 (1.0)
		0	3.0, 4.x, 16.6	
04	Cooling control	0	All*	CO2 > F04 - 1: Cooling control, only with CO2 > F11 - 1 The cooling control function causes a reversal of the operating direction and a minimum limitation of the return flow temperature in HC2.
05	Underfloor heating Drying of jointless floors	0	All*	CO2 > F05 - 1: Restriction of the adjustment ranges Function block parameters: Start temperature: 20.0 to 60.0 °C (25 °C) Hold (days): 0 to 10 days (0) Temp. rise/day: 0.0 to 10.0 °C (5.0 °C) Maximum temperature: 25.0 to 60.0 °C (45.0 °C) Hold (days): 0 to 10 days (4) Temp. reduction/day: 0.0 to 10.0 °C (0.0 °C) StoP, ■StArT, ■■■StArT, ■■■■StArT, ■■■■■StArT
07	Optimization of heating times	0	All*	CO2 > F07 - 1: only with CO2 > F01 - 1 and CO1 > F02 - 1
08	Adaptation of the heating characteristic curve	0	All*	CO2 > F08 - 1: only with CO2 > F01 - 1, CO1 > F02 - 1 and CO2 > F11 - 0

F	Function	WE	Anl	Comments Function block parameters: value range (default setting)
09	Flash adaptation of the flow temperature	0	All*	CO2 > F09 - 1: only with CO2 > F01 - 1 Function block parameters: Cycle time: 0 or 1 to 100 min (20 min) KP (gain): 0.0 to 25.0 (0.0)
11	Four-point characteristic	0	All*	CO2 > F11 - 1: Four-point characteristic, only with CO2 > F08 - 0 CO2 > F11 - 0: Gradient characteristic
12	Control mode	1	All*	CO2 > F12 - 1: Three-step control Function block parameters: KP (gain): 0.1 to 50.0 (2.0) Tn (reset time): 1 to 999 s (120 s) TV (derivative-action time): 0 s, do not change the value. TY (valve transit time): 15, ..., 240 s (120 s) CO2 > F12 - 0: On/off control Function block parameters: Hysteresis: 1.0 to 30.0 °C (5.0 °C) Min. ON time: 0 to 10 min (2 min) Min. OFF time: 0 to 10 min (2 min)
13	Limitation of set point deviation for OPEN signal	0	All*	CO2 > F13 - 1: only with CO2 > F12 - 1 Function block parameters: Max. system deviation: 3.0 to 10.0 °C (3.0 °C)
14	Release HC2 at input BI2	0	All*	With CO2 > F14 - 1 setting: FG2 has no function Select: BI = 1, BI = 0 (BI = 1)
16	Demand processing 0 to 10 V Input terminals 11/12	0	All*	CO2 > F16 - 1: demand processing in HC2 Function block parameters: Lower transmission range: 0 to 150 °C (0 °C) Upper transmission range: 0 to 150 °C (120 °C)

F Function block number, WE Default setting, Anl System code number

CO4: DHW circuit (systems Anl 1.1–1.3, 1.5, 1.6, 1.9, 2.x, 4.1, 4.5, 11.x)*

F	Function	WE	Anl	Comments Function block parameters: value range (default setting)
01	Storage tank sensor SF1	1	1.1–1.3, 1.5, 1.6, 2.x, 4.1, 4.5, 11.0, 11.2	CO4 > F01 - 0 (not system Anl 11.0): storage tank thermostat, only when CO4 > F02 - 0
		0	1.9, 11.9	

Appendix

F	Function	WE	Anl	Comments Function block parameters: value range (default setting)
02	Storage tank sensor SF2 with stop storage tank charging function (not assigned to the solar circuit)	0	1.1, 1.3, 1.5, 2.0, 2.1, 2.3, 4.1, 4.5, 11.0, 11.1, 11.5	CO4 > F02 - 1 (not systems Anl 1.3, 1.9, 2.3, 11.0 and 11.9): only when CO4 > F01 - 1
		1	1.2, 1.6, 2.2, 11.2	
03	Return flow sensor RüF2	0	1.9, 11.x	CO4 > F03 - 1: Sensor and limitation function active Function block parameter: KP (limiting factor): 0.1 to 10.0 (1.0)
05	Flow sensor VF4	0	1.1, 1.2, 1.6, 2.2	CO4 > F05 - 1: Flow sensor to measure storage tank charging temperature active
06	Parallel pump operation	0	2.1-2.3, 4.1, 4.5	CO4 > F06 - 1 Function block parameters: Stop parallel pump operation in the event of a system deviation: 0 to 10 min (10 min) Flow temperature limit for parallel operation: 20.0 to 90.0 °C (40.0 °C) CO4: F06 - 0: UP1 switched off during DHW heating
07	Intermediate heating	1	2.x, 4.1, 4.5	CO4 > F07 - 1: after 20 minutes of DHW heating, heating operation in UP1 circuit reactivated for 10 minutes CO4 > F07 - 0: storage tank charging is given unlimited priority concerning UP1 circuit
08	Priority through reverse control	0	1.1-1.3, 4.1, 4.5, 11.x	CO4 > F08 - 1: only with CO4 > F09 - 0 Function block parameters: Start: 0 to 10 min (2 min) KP (influence factor): 0.1 to 10.0 (1.0) System Anl 4.5 only: control circuit HC1, HC2, HC1+HC2 (HC2)
09	Priority through set-back operation	0	1.1-1.3, 4.1, 4.5, 11.x	CO4 > F09 - 1: only with CO4 > F08 - 0 Function block parameters: Start: 0 to 10 min (2 min) System Anl 4.5 only: HC1, HC2, HC1+HC2 (HC2)
10	Circulation pump (DHW) integrated into the heat exchanger	0	1.6, 11.2	CO4 > F10 - 1: Control of DHW circuit active while circulation pump (ZP) is running
		1	11.6	
11	Circulation pump operation during storage tank charging	0	1.1-1.3, 1.5, 1.6, 2.x, 4.1, 4.5, 11.1, 11.2	CO4 > F11 - 1: Circulation pump (ZP) runs according to time schedule during storage tank charging CO4 > F11 - 0: Circulation pump (ZP) switched off during storage tank charging

F	Function	WE	Anl	Comments Function block parameters: value range (default setting)
12	Control mode	1	1.9, 11.x	CO4 > F12 - 1: Three-step control Function block parameters: KP (gain): 0.1 to 50.0 (2.0; system Anl x.9: 0.6) Tn (reset time): 1 to 999 s (120 s; system Anl x.9: 12 s) TV (derivative-action time): 0 s, do not change the value. TY (valve transit time): 15, ..., 240 s (120 s; system Anl x.9: 20 s) CO4 > F12 - 0 (systems Anl 11.0, 11.1 only): On/off control Function block parameters: Hysteresis: 1.0 to 30.0 °C (5.0 °C) Min. ON time: 0 to 10 min (2 min) Min. OFF time: 0 to 10 min (2 min)
13	Limitation of set point deviation for OPEN signal	0	1.9, 11.x	CO4 > F13 - 1: only with CO4 > F12 - 1 Function block parameters: Max. system deviation: 3.0 to 10.0 °C (3.0 °C)
14	Thermal disinfection	0	All*	CO4 > F14 - 1: only with CO4 > F01 - 1 Function block parameters: Day of the week: 1, 2, ..., 7, 1-7 (3) Start time: 00:00 to 23:45 (00:00) Stop time: 00:00 to 23:45 (04:00) Disinfection temperature: 60.0 to 90.0 °C (70.0 °C) Set point boost: 0 to 50 °C (10 °C) Disinfection temperature sustaining time: 0 to 255 min (0 min) When the start time is set to the same time as the stop time Selection: Bl = 1, Bl = 0 (Bl = 1), input terminals 03/12 (only possible without SF2/RF2)
15	SLP ON depending on return flow temperature	0	1.5, 1.6, 2.0, 2.1, 2.3, 4.1, 11.1, 11.2	For systems Anl 1.5, 1.6, 2.0, 2.1, 2.3, 4.1: CO4 > F15 - 1: only when CO1 > F03 - 1 For systems Anl 11.1 and 11.2: CO4 > F15 - 1: only when CO4 > F03 - 1
16	Priority for external demand	0	1.5, 1.6, 2.x, 4.1	When CO4 > F16 - 1 is configured, a high external demand causes correspondingly excessive charging temperatures in DHW circuits without control valve.
19	Time-controlled changeover of storage tank sensors	0	1.1-1.3, 1.5, 1.6, 2.x, 4.1, 4.5, 11.1, 11.2	CO4 > F19 - 1: only when CO4 > F02 - 1 SF1 applies for day mode and SF2 for night mode.
20	DHW circuit additionally controlled by a globe valve	0	11.1	CO4 > F20 - 1: Return flow temperature limitation using the globe valve with VF2 in the heating register return flow of the storage tank

Appendix

F	Function	WE	Anl	Comments Function block parameters: value range (default setting)
21	Speed reduction of charging pump	0	1.1–1.3, 1.5, 1.6, 2.x, 4.1, 11.1, 11.2	CO4 > F21 - 1: Temperature-based adaptation of the delivery rate of the charging pump Function block parameters: Start speed reduction: 5 to 90 °C (40 °C) Stop speed reduction 5 to 90 °C (50 °C) Min. signal: 0 to 50 % (20 %)
22	Cold charging protection	0	1.1	CO4 > F22 - 1: Storage tank charging started when the primary flow temperature is high enough

F Function block number, WE Default setting, Anl System code number

CO5: System-wide functions (all systems)

If the controller indicates CO5 > F00 - 1, any access to the return flow, flow rate and capacity settings is locked.

F	Function	WE	Anl	Comments Function block parameters: value range (default setting)
01	Sensor	1	All	CO5 > F01 - 1, F02 - 0: Pt 1000
02	initialization	1		CO5 > F01 - 0, F02 - 0: PTC
03		0		CO5 > F01 - 1, F02 - 1: Ni 1000
04	Summer mode	0	Not systems Anl 1.5, 1.6, 1.9, 3.5	CO5 > F04 - 1: Activation of time-dependent summer mode Function block parameters: Start date for summer mode: 01.01 to 31.12 (01.06) No. days until activation: 1 to 3 (2) End date for summer mode: 01.01 to 31.12 (30.09) No. days until deactivation: 1 to 3 (1) Outdoor temperature limit for summer mode: 0.0 to 30.0 °C (18.0 °C)
05	Delayed outdoor temperature adaptation as the temperature falls	0	Not Anl 1.9	CO5 > F05 - 1 Function block parameters: Delay per hour: 1.0 to 6.0 °C (3.0 °C)
06	Delayed outdoor temperature adaptation as the temperature rises	0	Not Anl 1.9	CO5 > F06 - 1 Function block parameters: Delay per hour: 1.0 to 6.0 °C (3.0 °C)
08	Summer/standard time switchover	0	All	

F	Function	WE	Anl	Comments Function block parameters: value range (default setting)
09	Frost protection program II	1	Not systems Anl 1.5, 1.6, 1.9, 3.5	CO5 > F09 - 0: Frost protection program I (restricted frost protection) Function block parameters: Frost protection limit: -15.0 to +3.0 °C (3.0 °C)
		0	1.5, 1.6, 1.9, 3.5	CO5 > F09 - 1: Frost protection program II Function block parameters: Frost protection limit: -15.0 to +3.0 °C (3.0 °C)
10	Power limitation input BE2	0	Not Anl. 1.0, 1.5 - 1.9, 3.0, 3.5, 4.0, 10.x, 11.x, 16.x	CO5 -> F10 - 1: Power limitation in HC1 with pulses, only with CO6 > F12 - 0 Function block parameters: Maximum limit value: AT up to 800 lmp/h (15 lmp/h) Max. Heating mode*: AT up to 800 lmp/h (15 lmp/h) Max. drinking water*: 1 to 800 lmp/h (15 lmp/h) Limiting factor: 0.1 to 10.0 (1,0)
12	Creep feed rate limitation	0	Not Anl 1.9	CO5 > F12 - 1: Creep feed rate limitation Selection: bin (input terminals 04/12), AnA (input RüF1) Function block parameters when 'bin' is selected: bE = 1, bE = 0 (bE = 1)
14	Operation UP1	0	3.0, 16.x	CO5 > F14 - 1: feeder pump UP1 also starts to operate to cover the demand of HC2.
15	Release controller at input BI1	0	All	With CO5 > F15 - 1 setting: FG1 has no function Select: BI = 1, BI = 0 (BI = 1)
16	Return flow temperature limitation with P algorithm	0	All	CO5 > F16 - 1: Return flow temperature limitation only with proportional component
19	Temperature monitoring	0	All	CO5 > F19 - 1: Temperature monitoring active
20	Sensor calibration	1	All	CO5 > F20 - 1: Set all sensor calibration values CO5 > F20 - 0: Delete all sensor calibration values
21	Lock manual level	0	All	CO5 > F21 - 1: controller runs in automatic mode in  switch position
22	Lock the rotary switch	0	All	CO5 > F22 - 1: Rotary switch without any function. It is still possible to enter the key number.
23	Outdoor temperature as 0 to 10 V signal	0	All	CO5 > F23 - 1: Outdoor temperature received as 0 to 10 V signal (AE) or sent (AA), terminals 11/12 Function block parameters: Direction: AE, AA (AE) Lower transmission range: -50.0 to +100.0 °C (-20.0 °C) Upper transmission range: -50.0 to +100.0 °C (50.0 °C)
24	Input 0-10 V	0	All	CO5 -> F24 - 1: The measured value at input 0 to 10 V is displayed as special value

Appendix

F	Function	WE	Anl	Comments Function block parameters: value range (default setting)
---	----------	----	-----	--

F Function block number, WE Default setting, Anl System code number

CO5': System-wide functions (all systems)

F	Function	WE	Anl	Comments Function block parameters: value range (default setting)
01	AA1 reverse	0	All	CO5' > F01 - 0: 0 V/0 % = Valve CLOSED/pump OFF CO5' > F01 - 1: 0 V/0 % = Valve OPEN/pump with max. delivery rate Function block parameters: Zero: 0 to 50 % (0 %)
07	AI1 Zero shift	0	All*	CO5' > F07 - 0 Function block parameters: Zero: 5 to 20 % (5 %)

F Function block number, WE Default setting, Anl System code number

CO6: Modbus (all systems)

F	Function	WE	Anl	Comments Function block parameters: value range (default setting)
01	Modbus	1	All	CO6 > F01 - 1: Modbus active
02	16-bit address	0	All	CO6 > F02 - 1: Modbus 16-bit addressing (only with CO6 > F01 - 1) CO6 > F02 - 0: 8-bit addressing
03	Modem function	0	All	CO6 > F03...F06 is required to configure the error message transfer to a connected Modbus/GPRS gateway (0440210011)
04	Automatic modem configuration	0	All	
05	Lock dial-up to building automation system	0	All	
06	Dial-up to building automation system also to indicate that an error has been remedied	0	All	
07	Monitoring	0	All	CO6 > F07 - 1: Reset all even bits to 'autonomous' when there is no communication (only when CO6 > F01 - 1)
08	Text message	0	All	CO6 > F08 is required to configure the error message transfer to a connected Modbus/GPRS gateway (0440210011).

F	Function	WE	Anl	Comments Function block parameters: value range (default setting)
10	Meter bus (only with optional meter bus- Modbus gateway)	0 255	All	CO6 -> F10 - 1: Meter bus active Function block parameters: (each WMZ1 to WMZ6) Meter bus address / 0 to 255 Type code / 1434, CAL3, APA10, SLS Readout mode / 24h, CONT, Coil for WMZ1 with "1434" and "CONT" selection: tAr-A, tAr-E with time program
11	Flow rate limitation in HC1 via meter bus	0 1,5 m³/h 1,5 m³/h 1,5 m³/h 1	All	CO6 -> F11 - 1 only with - CO6 -> F10 - 1 CO5 -> F11 - 0 Function block parameters: Maximum limit value /At, 0.01 to 650 m³/h Maximum limit value heating operation* /At, 0.01 to 650 m³/h Maximum limit value drinking water* / 0.01 to 650 m³/h Limiting factor / 0.1 to 10
12	Power limitation in HC1 via meter bus	0	All	CO6 -> F12 - 1 only with - CO6 -> F10 - 1 - CO5 -> F10 - 0 Function block parameters: Maximum limit value /At, 0.1 to 6500 kW Maximum limit value heating operation* /At, 0.1 to 6500 kW Maximum limit value drinking water* / 0.1 to 6500 kW Limiting factor / 0.1 to 10
20	Modbus without building automation system	0	All	CO6 > F20 - 1: Various Modbus specifications do not have any effect on the collective level/building automation system reading

F Function block number, WE Default setting, Anl System code number

CO7: Device bus (all systems)

F	Function	WE	Anl	Comments Function block parameters: value range (default setting)
01	Device bus	0	All	CO7 -> F01 - 1: Device bus active Function block parameters: Device bus address/Auto ¹⁾ , 1 to 32 (32) ¹⁾ Auto = Automatic search for a free device bus address in the system
02	Clock synchronization	0	All	CO7 -> F02 - 1: controller sends its system time to all device bus participants once every 24 hours
03	reserved		All	
04	reserved		All	
05	reserved		All	

Appendix

F	Function	WE	Anl	Comments Function block parameters: value range (default setting)
06	Send AF1	0	All	CO7 -> F06 - 1: Function block parameters: Register number/1 to 4 (1)
07	Receive AF1	0	All	CO7 -> F07 - 1: Function block parameters: Register number/1 to 4 (1)
08	Send AF2	0	All	CO7 -> F08 - 1: Analysis active Function block parameters: Register number/1 to 4 (2)
09	Receive AF2	0	Not Anl 1.9	CO7 -> F09 - 1: Function block parameters: Register number/1 to 4 (2)
10	Send demand in HC1	0	All	CO7 -> F10 - 1: Send demand Function block parameters: Register number/5 to 64 (5)
11	Send demand in HC2	0	All	CO7 -> F11 - 1: Function block parameters: Register number/5 to 64 (5)
13	Send demand DHW	0	All	CO7 -> F13 - 1: 'Charging temperature boost' (P04) is generated in the PA4 level Function block parameters: Register number/5 to 64 (5)
14	Send max. demand	0	All	CO7 -> F14 - 1: the controller already determines internally the maximum flow set point of its circuit and sends it this value to the primary controllers
15	Receive external demand in HC1	0	All	CO7 -> F15 - 1: External demand processing in HC1 Function block parameters: Register number/5 to 64 (5)
16	Receive errors	0	All	CO7 -> F16 - 1: the controller generates the 'External' message as long as the faults of the other device bus participants exist.
17	Receive external demand in HC2	0	All	CO7 -> F17 - 1: External demand processing in HC2 Function block parameters: Register number/5 to 64 (5)
19	Raise return flow temperature	0	All	CO7 -> F19 - 1: Return flow temperature limit in HC1 raised when 'DHW heating active' message is received over the device bus Function block parameters: Register number/5 to 64 (32)
20	Send 'DHW heating active'	0	All	CO7 -> F20 - 1: Function block parameters: Register number/5 to 64 (32)
21	Receive release HC1	0	All	CO7 -> F21 - 1: Function block parameters: Register number/5 to 64 (32)

F	Function	WE	Anl	Comments Function block parameters: value range (default setting)
22	Receive release HC2	0	3.1–3.4, 4.x, 5.x, 6.x, 10.x, 16.1, 16.6, 16.8, 25.x	CO7 -> F22 - 1: Function block parameters: Register number/5 to 64 [32]



CO8: Initialization of BI1 and BI2 (all systems)

F	Function	WE	Anl	Comments Function block parameters: value range (default setting)
01	Analysis of BI1	0	All	CO8 > F01 - 1: analysis active Function block parameters: Error message when BI = 0, BI = 1, none (1)
02	Analysis of BI2	0	All	CO8 > F02 - 1: analysis active Function block parameters: Error message when BI = 0, BI = 1, none (1)



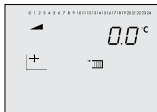

10.2 Parameter lists







PA1: PA1 parameters (heating circuit 1)

PA2: PA2 parameters (heating circuit 2)







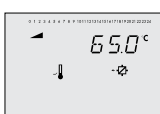

Display reading	Parameter name Value range (default setting)
	Flow gradient 0.2 to 3.2 (1.8) (when CO1, 2 > F05 - 1, 0.2 to 1.0 (1.0) applies)
	Level (parallel shift) -30.0 to +30.0 °C (0.0 °C)
	Min. flow temperature -5.0 to +150.0 °C (20.0 °C)

Appendix

Display reading	Parameter name Value range (default setting)
	<p>Max. flow temperature</p> <p>5.0 to 150.0 °C (90.0 °C) When CO1, 2 > F05 - 1: 5.0 to 50.0 °C (50.0 °C)</p>
	<p>Four-point characteristic</p> <p>Press rotary pushbutton [✱] to set the following parameters:</p> <ul style="list-style-type: none"> Outdoor temperature Flow temperature Reduced flow temperature Return flow temperature
	<p>Four-point characteristic</p> <p>Point 1: outdoor temperature</p> <p>Outdoor temperatures of points 2, 3 and 4 are marked by squares under the numbers 2, 3 and 4.</p> <p>-50.0 to +50.0 °C (pt. 1: -15.0 °C, pt. 2: -5.0 °C, pt. 3: 5.0 °C, pt. 4: 15.0 °C) When CO1, 2 > F04 - 1 (pt. 1: 5.0 °C, pt. 2: 15.0 °C, pt. 3: 25.0 °C, pt. 4: 30.0 °C)</p>
	<p>Four-point characteristic</p> <p>Point 1: flow temperature</p> <p>Flow temperatures of points 2, 3 and 4 are marked by squares under the numbers 2, 3 and 4.</p> <p>-5.0 to +150.0 °C (pt. 1: 70.0 °C, pt. 2: 55.0 °C, pt. 3: 40.0 °C, pt. 4: 25.0 °C) When CO1, 2 > F04 - 1: (pt. 1: 20.0 °C, pt. 2: 15.0 °C, pt. 3: 10.0 °C, pt. 4: 5.0 °C)</p>
	<p>Four-point characteristic</p> <p>Point 1: reduced flow temperature</p> <p>Reduced flow temperatures of points 2, 3 and 4 are marked by squares under the numbers 2, 3 and 4.</p> <p>-5.0 to +150.0 °C (pt. 1: 60.0 °C, pt. 2: 40.0 °C, pt. 3: 20.0 °C, pt. 4: 20.0 °C) When CO1, 2 > F04 - 1: (pt. 1: 30.0 °C, pt. 2: 25.0 °C, pt. 3: 20.0 °C, pt. 4: 15.0 °C)</p>



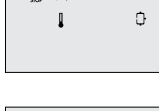

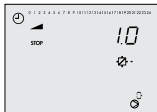

Display reading	Parameter name
	<p>Value range (default setting)</p> <p>Four-point characteristic Point 1: return flow temperature</p> <p>Return flow temperatures of points 2, 3 and 4 are marked by squares under the numbers 2, 3 and 4. 5.0 to 90.0 °C (points 1 to 4: 65.0 °C)</p>
	<p>OT deactivation value in rated operation</p> <p>0.0 to 50.0 °C (22.0 °C)</p>
	<p>OT deactivation value in reduced operation</p> <p>-50.0 to +50.0 °C (15.0 °C)</p>
	<p>OT activation value in rated operation</p> <p>-50.0 to +5.0 °C (-15.0 °C)</p>
	<p>Return flow gradient</p> <p>0.2 to 3.2 (1.2)</p>
	<p>Return flow level</p> <p>-30.0 to +30.0 °C (0.0 °C)</p>
	<p>Base point for return flow temperature:</p> <p>5.0 to 90.0 °C (65.0 °C)</p>

Appendix

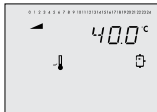



Display reading	Parameter name Value range (default setting)
	Max. return flow temperature 5.0 to 90.0 °C (65.0 °C)
	Set point boost (primary exchanger control) 0.0 to 50.0 °C (5.0 °C)
	Set point for binary demand processing 0.0 to 150.0 °C (40.0 °C)
	Only in PA1 parameter level Flow set point, day -5.0 to +150.0 °C (50.0 °C)
	Only with flash adaptation without outdoor sensor Flow set point, night -5.0 to +150.0 °C (30.0 °C)
	Only with flash adaptation without outdoor sensor Minimum set point to charge buffer tank OT to 90.0 °C (AT)
	In PA1 only Stop charging of the buffer tank OT to 90.0 °C (AT)
	In PA1 only Charging temperature boost 0.0 to 50.0 °C (6.0 °C)
	In PA1 only

Display reading	Parameter name
	Value range (default setting)
	Lag time of charging pump
	0.0 to 10.0 (1.0)
	In PA1 only



PA4: DHW circuit parameters



Display reading	Parameter name
	Value range (default setting)
	Min. DHW temperature
	5.0 to 90.0 °C (40.0 °C)
	Max. DHW temperature
	5.0 to 90.0 °C (60.0 °C)
	Hysteresis
	1.0 to 30.0 °C (5.0 °C)
	Charging temperature boost
	0.0 to 50.0 °C (10.0 °C)
	Max. charging temperature (only with VF4)
	20.0 to 150.0 °C (80.0 °C)
	Lag time for storage tank charging pump
	0.0 to 10.0 (1.0)

Appendix

Display reading	Parameter name Value range (default setting)
	Max. return flow temperature 20.0 to 90.0 °C (65.0 °C)
	Solar circuit pump ON 1.0 to 30.0 °C (10.0 °C)
	Solar circuit pump OFF 0.0 to 30.0 °C (3.0 °C)
	Max. storage tank temperature 20.0 to 90.0 °C (80.0 °C)
	Control signal DHW for storage tank charging 5 to 100 % (100 %)

PA5: System-wide parameters (all systems)

Display reading	Parameter name Value range (default setting)
	Boiler pump ON 20 to 90 °C (60 °C) System Anl 16.x only
	Hysteresis 0 to 30 °C (5 °C) System Anl 16.x only

Display reading	Parameter name
	Public holidays Value range (default setting) (01.01 to 31.12, see section 2.8.1)
	Vacations Value range (default setting) (01.01 to 31.12, see section 2.8.2)

PA6: Modbus parameters

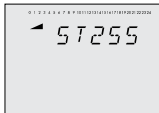
Display reading	Parameter name
	Station address Value range (default setting) 1 to 247 (255) (when CO6 > F02 - 1: 1 to 32000 applies)

10.3 Resistance values

Resistance values with Ni 1000 resistors (according to DIN 43760)

Temp. °C	-35	-30	-25	-20	-15	-10	-5	0	5	10	15	20
Resistance Ω	816.2	841.5	867.0	893.0	919.2	945.8	972.7	1000.0	1027.6	1055.5	1083.8	112.4
Temp. °C	25	30	35	40	45	50	55	60	65	70	75	80
Resistance Ω	1141.3	1170.6	1200.2	1230.1	1260.4	1291.1	1322.0	1353.4	1385.1	1417.2	1449.7	1482.5
Temp. °C	85	90	95	100	105	110	115	120	125	130	135	140
Resistance Ω	1515.7	1549.3	1583.4	1617.8	1652.6	1687.9	1723.6	1759.7	1796.3	1833.3	1870.9	1908.9
Temp. °C	145	150										
Resistance Ω	1947.4	1986.3										

10.4 Technical data

Inputs	8 inputs for Pt 1000, PTC or Ni 1000 temperature sensors and 2 binary inputs, terminal 11 as 0 to 10 V input (e.g. for external demand or outdoor temperature signal)
Outputs	2x three-step signal: load max. 250 V AC, 2 A ¹⁾ Alternatively 2x on/off signal: load max. 250 V AC, 2 A ¹⁾ 3x pump output: load max. 250 V AC, 2 A ¹⁾ , all outputs are relay outputs with varistor suppression Terminal 11 as 0 to 10 V output (e.g. for continuous closed loop control, outdoor temperature, signal for external demand or pump speed control), load >5 k Ω For systems with one control circuit, a maximum of four pumps are available
Optional interfaces	1x Modbus RS-485 interface for two-wire bus using RS-485 communication module (Modbus RTU protocol, data format 8N1, RJ45 connector socket at the side)
Supply voltage	85 to 250 V, 48 to 62 Hz, max. 1.5 VA
Ambient temperature	0 to 40 °C (operation) -10 °C to +60 °C (storage and transport)
Degree of protection	IP 40 according to EN 60529
Class of protection	II according to EN 61140
Degree of contamination	2 according to EN 61010
Overvoltage category	II according to EN 60664
Noise immunity	According to EN 61000-6-1
Noise emission	According to EN 61000-6-3
Weight	Approx. 0.5 kg
Compliance	

¹⁾ Inrush current, max. 16 A

EQJW146F001



SAUTER Deutschland
Sauter-Cumulus GmbH
Hans-Bunte-Str. 15
79108 Freiburg

<http://www.sauter-cumulus.de>
Telefon +49 (761) 5105-0
Telefax +49 (761) 5105-234

E-Mail: sauter-cumulus@de.sauter-bc.com

Revisionsnr.: A, Datum: 25.05.2021